



NGX-1-ISO

NGX-1-USB

NMEA 2000 Gateway

Install / User manual

European Union

The full text of the EU declaration of conformity is available at the following internet address:

https://www.actisense.com/acti_download/NGX-1-declaration-of-conformity

Hereby, Active Research Ltd declares that the NGX-1 is in compliance with the essential requirements and other relevant provisions of Directive 2014/53/EU.

Active Research Ltd tímto prohlašuje, že tento NGX-1 je ve shodě se základními požadavky a dalšími příslušnými ustanoveními směrnice 2014/53/EU.

Undertegnede, Active Research Ltd erklærer herved, at følgende udstyr NGX-1 overholder de væsentlige krav og øvrige relevante krav i direktiv 2014/53/EU.

Hiermit erklärt, Active Research Ltd dass sich das Gerät NGX-1 in Übereinstimmung mit den grundlegenden Anforderungen und den übrigen einschlägigen Bestimmungen der Richtlinie 2014/53/EU befindet.

Käesolevaga kinnitab, Active Research Ltd seadme NGX-1 vastavust direktiivi 2014/53/EL põhinõuetele ja nimetatud direktiivist tulenevatele teistele asjakohastele sätetele.

Por medio de la presente Active Research Ltd declara que el NGX-1 cumple con los requisitos esenciales y cualesquiera otras disposiciones aplicables o exigibles de la Directiva 2014/53/UE.

ΜΕ ΤΗΝ ΠΑΡΟΥΣΑ, Active Research Ltd ΔΗΛΩΝΕΙ ΟΤΙ NGX-1 ΣΥΜΜΟΡΦΩΝΕΤΑΙ ΠΡΟΣ ΤΙΣ ΟΥΣΙΩΔΕΙΣ ΑΠΑΙΤΗΣΕΙΣ ΚΑΙ ΤΙΣ ΛΟΙΠΕΣ ΣΧΕΤΙΚΕΣ ΔΙΑΤΑΞΕΙΣ ΤΗΣ ΟΔΗΓΙΑΣ 2014/53/ΕΕ.

Par la présente, Active Research Ltd déclare que l'appareil NGX-1 est conforme aux exigences essentielles et aux autres dispositions pertinentes de la directive 2014/53/UE.

Con la presente, Active Research Ltd dichiara che questo NGX-1 è conforme ai requisiti essenziali ed alle altre disposizioni pertinenti stabilite dalla direttiva 2014/53/UE.

Ar šo Active Research Ltd deklarē, ka NGX-1 atbilst Direktīvas 2014/53/ES būtiskajām prasībām un citiem ar to saistītajiem noteikumiem.

Šiuo Active Research Ltd deklaruoja, kad šis NGX-1 atitinka esminius reikalavimus ir kitas 2014/53/ES Direktyvos nuostatas.

Hierbij verklaart, Active Research Ltd dat het toestel NGX-1 in overeenstemming is met de essentiële eisen en de andere relevante bepalingen van richtlijn 2014/53/EU.

Hawnhekk, Active Research Ltd, jiddikjara li dan NGX-1 jikkonforma mal-ħtiġijiet essenzjali u ma provvedimenti oħrajn rilevanti li hemm fid-Dirrettiva 2014/53/UE.

Alulírott, Active Research Ltd nyilatkozom, hogy a NGX-1 megfelel a vonatkozó alapvető követelményeknek és az 2014/53/EU irányelv egyéb előírásainak.

Niniejszym Active Research Ltd oświadcza, że NGX-1 jest zgodny z zasadniczymi wymogami oraz pozostałymi stosownymi postanowieniami Dyrektywy 2014/53/UE.

Active Research Ltd declara que este NGX-1 está conforme com os requisitos essenciais e outras disposições da Directiva 2014/53/UE.

Active Research Ltd izjavlja, da je ta NGX-1 v skladu z bistvenimi zahtevami in ostalimi relevantnimi določili direktive 2014/53/EU.

Active Research Ltd tímto vyhlasuje, že NGX-1 spĺňa základné požiadavky a všetky príslušné ustanovenia Smernice 2014/53/EÚ.

Active Research Ltd vakuuttaa täten että NGX-1 tyyppinen laite on direktiivin 2014/53/EU oleellisten vaatimusten ja sitä koskevien direktiivin muiden ehtojen mukainen.

Härmed intygar Active Research Ltd att denna NGX-1 står i överensstämmelse med de väsentliga egenskapskrav och övriga relevanta bestämmelser som framgår av direktiv 2014/53/EU.

Hér með lýsir Active Research Ltd yfir því að NGX-1 er í samræmi við grunnkröfur og aðrar kröfur, sem gerðar eru í tilskipun 2014/53/EU.

Active Research Ltd erklærer herved at utstyret NGX-1 er i samsvar med de grunnleggende krav og øvrige relevante krav i direktiv 2014/53/EU.

Noi, Active Research Ltd, declarăm pe propria noastră răspundere că produsul NGX-1 este în conformitate cu cerințele esențiale și celelalte prevederi aplicabile ale Directivei 2014/53/UE

Contents Page

- **Important notices**.....4
- **Installation warnings**.....5
- **Regulatory & Safety Notices**.....6
- **About the NGX-1**.....7
 - Modes Explained
 - NGX-1 variants
- **Powering the NGX-1**.....8
 - Connecting to a USB port
 - USB Driver Installation
 - Connecting to an NMEA 2000 Network
 - Actisense Software
 - Minimum NMEA 2000 network requirements.....9
- **Connecting to an NGX-1-ISO**.....10-12
 - Connecting to an NMEA 0183 device
 - Connecting to an RS-422 USB-Serial converter (USG-2 or similar)
 - Connecting to an RS-232 USB-Serial Device
 - Connecting to a 9-pin D-type socket
 - Connecting to a Raymarine SeaTalk^{NG} network
- **Installing an NGX-1-ISO to an NMEA 0183 device(Convert Mode)**.....13
 - Installing an NMEA0183 device @ 4,800 baud : Standard Conversions.
 - Installing an NMEA0183 device @ 38,400 baud : AIS Conversions
- **Installing an NGX-1-USB as an NMEA 2000 Gateway(Transfer Mode)**.....14
 - Swapping between modes of operation (Transfer <-> Convert).....15
 - Baud rate alteration using NMEA Reader.....16-17
 - Conversion alterations using Actisense Toolkit.....18-19
 - Configuring Rx & Tx conversions.....20
 - Firmware updates using Toolkit.....21
 - Manual installation of Firmware updates.....22
 - LED behaviour & troubleshooting.....23
 - Returns procedure.....24
 - Technical Specifications.....25
 - Dimensional drawing.....26

Important Notices

Trademarks and Registered Trademarks

Actisense® and the Actisense logo are registered trademarks of Active Research Limited (Ltd). All other trademarks are the property of their respective owners.

The NMEA® name and NMEA logo are copyright held by the NMEA. All uses in this manual are by permission and no claim on the right to the NMEA name or logo are made in this manual.

Fair Use Statement

The contents of this manual may not be transferred or copied without the express written permission of Active Research Ltd. Copyright © 2023 Active Research Ltd. All rights reserved.

Technical Accuracy

To the best of our knowledge the information contained in this document was correct at the time it was produced. Active Research Ltd cannot accept liability for any inaccuracies or omissions.

The products described in this manual and the specifications thereof may be changed without prior notice. Active Research Ltd cannot accept any liability for differences between the product and this document. To check for updated information and specifications please check www.actisense.com.

Active Research Ltd will not be liable for infringement of copyright, industrial property rights, or other rights of a third party caused by the use of information or drawings described in this manual.

Product Registration

Please register your product via the online form at www.actisense.com/support/prodreg.

Your product package includes a unit serial number. The serial number is six digits long and can be found below the barcode on the label. Your registration will assist Actisense Support to link your product to your details, simplifying any future assistance you may require.

Product Guarantee

All Actisense products are provided with a 3 year guarantee as standard. To activate the 5-year guarantee offered with this product please complete product registration online at www.actisense.com/support/prodreg.

If you suspect that the unit is faulty please refer to the Troubleshooting Section of the User Manual before contacting support.

It is a requirement of the guarantee that all installations of electronic equipment follow the NMEA 0400 specification. Any connection to a battery or power supply must meet the mandatory essential safety requirements that may be imposed by local regulatory agencies.

Actisense products are intended for use in a marine environment, primarily for below deck use. If a product is to be used in a more severe environment, such use may be considered misuse under the Active Research Ltd guarantee.

Product Disposal

Please consider the environment when disposing of this product. It should be disposed of according to the European WEEE Directive, or according to the applicable local regulations for the disposal of electrical equipment

The product packaging is recyclable.

All features and specifications may change without notice.



Installation Warnings

- **All warnings and notices must be followed to ensure the correct operation of the NGX-1.**
- **Incorrect installation may invalidate the guarantee. It is highly recommended that all of the installation instructions are read before commencing the installation.**
- **There are important warnings and notes throughout the manual that should be considered before the installation is attempted.**

Warning 1: Accuracy

The Actisense NGX-1 is designed to reliably transfer NMEA 2000 PGNs bi-directionally between a PC and the NMEA 2000 bus, **or** convert NMEA 0183 data bi-directionally between an 0183 device and the NMEA 2000 bus, according to the published conversion lists. Furthermore, for each installation requirement, the NGX-1 must be configured correctly by the software application. The NGX-1 should only be used as an aid to vessel monitoring, control or navigation and should not be used as a replacement for traditional aids and techniques.

Warning 2: Installation and Operation

This product must be installed and operated in accordance with the instructions provided. Failure to do so could result in personal injury, damage to your boat and/or poor product performance.

Warning 3: Installation Code of Practice

When wiring the power supply to the NGX-1 ensure the isolation switch is off. Wiring the NGX-1 while the connection is live may damage the NGX-1 and is in breach of the guarantee. Any connection to a battery or power supply must meet the mandatory essential safety requirements that may be imposed by local regulatory agencies, this should include suitable fusing.

All wiring should be in accordance with the requirements of the NMEA 0400 installation specification

Warning 4: Firmware Updates

It is highly recommended that the Firmware is kept up to date on the NGX-1. The latest firmware version number and details of supporting software such as NMEA Reader can be found on the NGX-1 downloads web page. You can check the firmware version currently installed in your NGX-1 by locating the manufacturers software ID on the network list found in most NMEA 2000 MFDs or NMEA Reader.

Warning 5: Mounting Requirements

Do not mount the NGX-1 while the device is powered.
Do not mount the NGX-1 while the NMEA 2000 cable is connected.
Do not mount the NGX-1 while the PC cable is connected.

Warning 6: Mounting Locations

Select a flat location to mount the NGX-1. Mounting on a contoured surface may cause damage to the case. Do not mount the NGX-1 in the same plane as transmitting or receiving antennas. Do not mount the NGX-1 close to an electronic compass. If the device to which this manual relates is to be installed within five metres of a compass, please refer to the 'Compass Safe Distance' section in the technical specifications at the end of this manual. This device should not be operated within 20cm of a human body. To avoid potential injury, it should be mounted at a height of less than 2m from floor level.

Regulatory & Safety Notices

USA: Federal Communications Commission (FCC) Statement

This device complies with FCC part 15 FCC Rules. Operation is subject to the following two conditions:

1. This device may not cause harmful interference.
2. This device must accept any interference, including interference that may cause undesired operation of the device.

FCC Warning

Changes or modifications not expressly approved by the party responsible for compliance could void the user's authority to operate the equipment.

NOTE: This equipment has been tested and found to comply with the limits for a Class B digital device, pursuant to part 15 of the FCC Rules. These limits are designed to provide reasonable protection against harmful interference in a residential installation. This equipment generates, uses and can radiate radio frequency energy and, if not installed and used in accordance with the instructions, may cause harmful interference to radio communications. However, there is no guarantee that interference will not occur in a particular installation. If this equipment does cause harmful interference to radio or television reception, which can be determined by turning the equipment off and on, the user is encouraged to try to correct the interference by one or more of the following measures:

- Reorient or relocate the receiving antenna.
- Increase the separation between the equipment and receiver.
- Connect the equipment into an outlet on a circuit different from that to which the receiver is connected.
- Consult the dealer or an experienced radio/TV technician for help.

This device meets the FCC and IC requirements for RF exposure in public or uncontrolled environments.

Canada: Industry Canada (IC) Statement

IC Notice to Users English/French in accordance with RSS GEN Issue 3:

This device complies with Industry Canada license exempt RSS standard(s).

Operation is subject to the following two conditions:

1. This device may not cause interference, and
2. This device must accept any interference, including interference that may cause undesired operation of the device.

Cet appareil est conforme avec Industrie Canada RSS standard exempts de licence(s). Son utilisation est soumise à Les deux conditions suivantes:

1. cet appareil ne peut pas provoquer d'interférences et
2. cet appareil doit accepter Toute interférence, y compris les interférences qui peuvent causer un mauvais fonctionnement du dispositif

This Class B digital apparatus complies with Canadian ICES-003.

Cet appareil numérique de la classe B est conforme à la norme NMB-003 du Canada

About the NGX-1

The NGX-1 from Actisense is an NMEA certified device which can operate in two distinct modes, depending on user requirements.

Transfer Mode : NMEA 2000 to PC interface(ISO or USB variant)

or

Convert Mode : NMEA 0183 <-> NMEA2000 bi-directional converter(ISO or USB variant)

Modes explained

In Transfer Mode, (Status = ●) the NGX-1 operates as an NMEA 2000 to PC interface, providing an easy way to link a PC to an NMEA 2000 network. In this mode it makes it possible for software applications to read and write to an NMEA 2000 bus while maintaining network integrity.

In Convert Mode, (Status = ●) the NGX-1 operates as a data converter, allowing the older NMEA 0183 networks & equipment to co-exist with modern NMEA 2000 networks. It provides a bi-directional facility allowing NMEA 0183 sentences to be converted into NMEA 2000 PGN messages, and vice-versa. A default set of conversions is pre-configured which covers most standard conversion requirements (including AIS conversion from NMEA 0183 to NMEA 2000).

To adjust these conversions (e.g. to configure fast heading or bi-directional AIS) please see page xx for more details.

Note: Not all PGN messages have an equivalent NMEA 0183 sentence. Many NMEA 2000 PGN's have been created and have not been transferred back to the NMEA 0183 standard. Please see the conversion list on our website - www.actisense.com.

NGX-1 Variants

ISO Variant (NGX-1-ISO):

The NGX-1-ISO is supplied with a 0.75m NMEA 0183 4-wire "differential pair" cable for connecting directly to NMEA 0183 equipment. NMEA standard wire colours are applied.

This allows for the NGX-1-ISO to be installed directly to an NMEA 0183 device without the need for further set-up in most circumstances.

USB Variant (NGX-1-USB):

The NGX-1-USB is supplied with a 1.8m USB cable (USB plug type B) for direct connection to a PC or laptop.

This allows the NGX-1-USB to interface with compatible apps. on a PC and run directly without the need for further set-up in most circumstances.

Powering the NGX-1

Both variants of the NGX-1 (ISO & USB) receive power supply when connected to a correctly powered and terminated NMEA 2000 backbone. See page 9 for the minimum bus requirements.

Note: Make sure that the blue 'Power' LED is illuminated for correct operation of the NGX-1. See LED behaviour table on page 23.

Connecting to a USB Port

For USB variants of the NGX-1, simply plug the USB cable on the NGX-1 in to a PC USB port and the USB driver installation will begin. For ISO variants of the NGX-1, a USB to serial converter cable can be used to connect to a PC USB port. For wiring the NGX-ISO cable refer to the instructions given on pages 11 & 12.

USB Driver Installation

Windows 7, 8, 10 & 11 will automatically install the drivers from Windows Update if there is an active Internet connection the first time the NGX-1 is plugged in. If the PC is not connected to the Internet or if the USB driver does not install automatically on the first installation of the NGX-1, the 'Update Driver Software' option in Device Manager will need to be used to install the USB drivers manually. Please visit the Actisense website at www.actisense.com to download the latest drivers should they be required.

Connecting to an NMEA 2000 network

The diagrams on page 9 show how each of the NGX-1 variants sit on an NMEA 2000 network.

NGX-1-ISO

The most common use case for the NGX-1-ISO is as an NMEA 0183 <-> NMEA 2000 converter.

In this situation, the NGX-1-ISO is wired directly into an NMEA 0183 device allowing data to pass through the NGX-1, be converted, and then be placed directly onto the NMEA 2000 bus. The data-flow is bi-directional allowing NMEA 2000 PGN's to be converted back to the NMEA 0183 device if required.

Note: The NGX-1-ISO may require some additional set-up to allow the bi-directional conversion of AIS sentences. This uses our free Toolkit software, and requires access to a serial-USB converter. Additionally, configuration can be accomplished using an Actisense NGT-1-USB if available.

Connecting the ISO-wires with a serial-USB converter also allows a direct connection to a PC/laptop. In this situation, the NGX-1-ISO can utilise both modes of operation (Transfer or Convert).

NGX-1-USB

The most common use case for the NGX-1-USB is as an NMEA 2000 to PC interface (Transfer mode), allowing a compatible PC application to interact with an NMEA 2000 network. It can however be placed into 'Convert' mode should you wish to convert NMEA 2000 data back into NMEA 0183 to be viewed on any PC application which utilises NMEA 0183 (eg. OpenCPN).

Actisense Software

Actisense supplies the following free software which will be required to configure the NGX-1 into the required state.

- **NMEA reader**
- **Actisense Toolkit**
- Please visit <https://actisense.com/nmea-software/> to download this software.

NGX-1-ISO connection to an NMEA 2000 network



NGX-1-USB connection to an NMEA 2000 network



NMEA 2000 Minimum Network Requirement

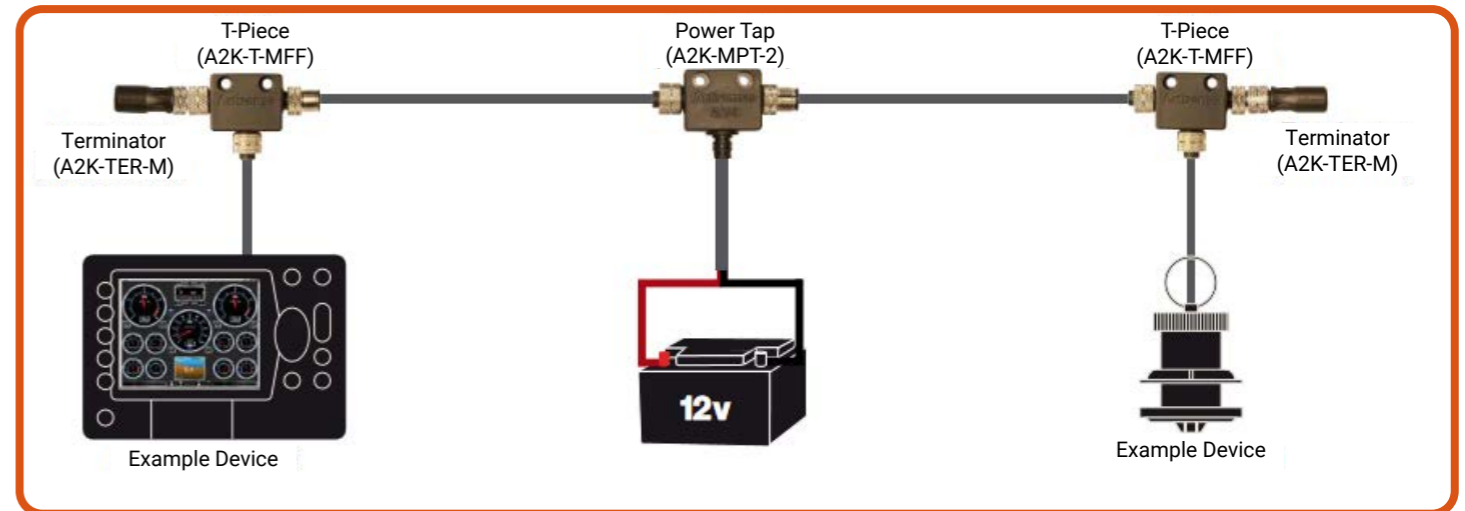

All NMEA 2000 networks require a 12V DC supply. In addition, a correctly functioning network will require the following components as a minimum:

- 1x Power T
- 2x Termination resistors
- 2x T-Pieces(one per connected device)
- 2x NMEA 2000 Devices (Such as an MFD & NGX-1)

Connecting to an NGX-1-ISO

There are several ways which the NGX-1-ISO can be connected, but the most common requirement will be to integrate an NMEA 0183 device to an NMEA 2000 network.

The NGX-1-ISO communicates using the RS-422 protocol which requires that data is sent and received using two pairs of wires. These are often termed as a "differential" pair.

The two pairs of wires are normally designated as:

- **Talker pair (A+ / B-):** This is the pair over which data is **sent from** an NMEA 0183 device.
- **Listener Pair (A+ / B-):** This is the pair over which the device **receives** NMEA 0183 data.

Currently, the specified NMEA 0183 signal colour coding for individual wires is as follows:

• Talker (A+) - WHITE	
• Talker (B-) - BROWN	
• Listener (A+) - YELLOW	
• Listener (B-) - GREEN	

The wiring on the NGX-1-ISO follows the above convention for the data pairs, and if followed, should make wiring NMEA 0183 devices which have the same colour coding easier to achieve. Please refer to the instructions of the device which you are connecting to your NGX-1 for more details.

The following diagrams show how to connect to the most popular devices:

A - Connect to an NMEA 0183 Device

Connect the NGX-1-ISO as shown in the diagram overleaf. If the device conforms to the NMEA 0183 standard, it should have the appropriate talker (A+ & B-) and listener (A+ & B-) pair clearly marked. Consult the manual or contact the manufacturer if unsure.

B - Connect to a PC with an Actisense USG-2. USB to Serial Gateway (RS-422)

Should you require to connect your NGX-1-ISO to a PC, you can attach an RS-422-Serial converter such as the Actisense USG-2. (<https://actisense.com/products/usg-2-nmea-0183-converter/>)

Note: To communicate with your NGX-1, select the USG-2 COM port displayed in "Device Manager"

C - Connect to a PC using and RS-232 Serial to USB converter

The NGX-1-ISO can also be connected to an RS-232 Serial converter if required. There are many such devices available and the diagram depicts a standard general outline only. The two B/- wires are connected together at a common ground.

Note: To communicate with your NGX-1, select the COM port for the converter in "Device Manager"

D - Connect to a serial port using a D-TYPE 9-pin socket

The NGX-1-ISO can also be connected to the older D-type 9 pin serial port should you wish to connect it directly into a serial port card on your PC. The serial connection is RS-232 and the two B/- wires are connected together at a common ground (pin 5).

Connecting to an NGX-1-ISO (contd)

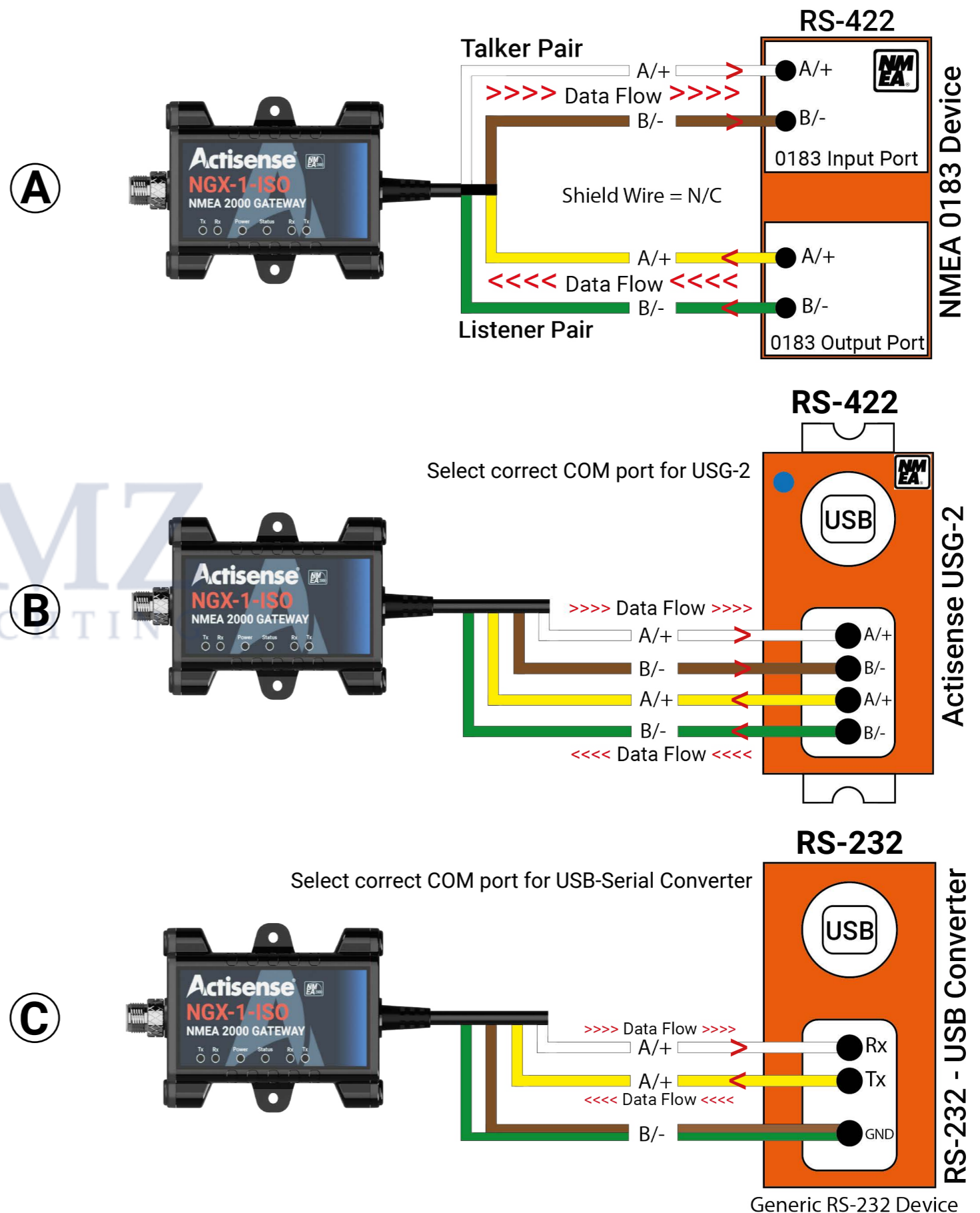

Connecting to an NGX-1-ISO (contd)

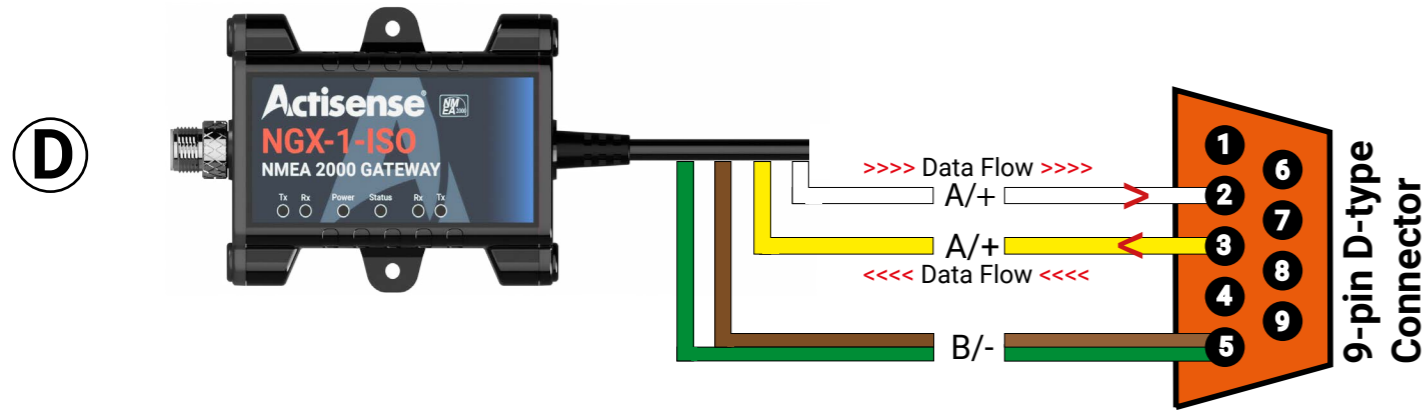

Connecting to a Raymarine SeaTalk^{NG} Network

Raymarine’s SeaTalk^{NG} network uses exactly the same data as a standard NMEA 2000 network. The only difference is the physical network connections. To connect any standard NMEA 2000 device (like the NGX-1) to an STNG network, simply use an NMEA 2000 to STNG adapter cable (product code: STNG-A06045) between the device and the STNG network.

Connecting an NGX-1-ISO to an NMEA 0183 device (Convert Mode)

The NGX-1-ISO is shipped with a default configuration to allow for an easy set-up when installing to devices running at either of the two common baud rates (4,800 or 38,400).

The default mode is set to ‘Convert’ (Status = ●)

The default baud rate is set to 4,800 allowing devices outputting at this speed to be installed quickly.

Autobaud

Auto baud is a feature which allows the NGX-1-ISO to automatically detect the rate of the incoming data and adjust itself accordingly. For example, connection to an NMEA 0183 talker outputting data at 38,400 baud will force the NGX-1 (after a delay of approximately 15 seconds) to accept data at that speed. As mentioned above, the device accepts data at 4,800 baud by default.

The NGX-1 will auto-baud to any baud rate between 4,800 and 230,400 baud in ‘Convert’ mode. This allows the NGX to automatically adjust to any commonly used baud rates without the need for any further configuration.

The NGX can be switched to ‘Transfer’ mode to transfer NMEA 2000 data to PC. Supported PC applications (e.g. Actisense NMEA Reader, Supported Chartplotter Apps etc.) will automatically change the NGX-1 into ‘Transfer’ mode. In ‘transfer’ mode it will use 115,200 by default but will autobaud to 230,400 to allow ‘Transfer’ of all PGN’s even on a busy NMEA 2000 bus.

The baud rate can be manually changed and the NGX-1 will remember the last used baud rate for each mode.

To connect an NGX-1-ISO to an NMEA 0183 device please follow these steps (also see page 9):

- Make sure the NMEA 0183 device is powered off before commencing wiring.
- Connect the NGX-1-ISO to an NMEA 0183 device using wiring diagram A shown on page 11. Please consult the instruction manual for the 0183 device if unsure.
- Connect the M12 5-pin connector to a spare port on the NMEA 2000 network. We do recommend a suitable truck-drop cable to attach to the NMEA 2000 bus if available.
- Power-on the NMEA 0183 device, and make sure that the NMEA 2000 network is also powered, and correctly terminated(see page 9).
- NGX-1-ISO will begin converting NMEA 0183 sentences into NMEA 2000 PGN’s and these will be placed onto the NMEA 2000 network.
- **PLEASE NOTE:** While the NMEA 0183 AIS Rx sentences (VDM & VDO) are switched on and are passed through the NGX-1 for conversion to NMEA 2000 PGN’s, AIS Tx sentences are switched off by default. This is done to prevent AIS PGN’s from being converted back to NMEA 0183 at the slower baud rate of 4,800, which would limit the bandwidth for other required sentences being transmitted at 4,800 baud.
- Please see page 18 & 19 for using Actisense Toolkit for applying the NMEA 0183 Tx conversions if they are required.

Installing an NGX-1-USB as an NMEA 2000 Gateway (Transfer Mode)

The NGX-1-USB variant has been developed to primarily operate as an NMEA 2000 gateway to transfer NMEA 2000 data to supported PC applications (such as navigation apps)

- Automatically switches to 'Transfer' mode on connection to a compatible app on a PC.
- Baud rate switches to 115,200 by default on connection to an compatible app on a PC.

This allows the NGX-1-USB to interface with compatible apps. on a PC/laptop and run directly without the need for further set-up in most circumstances.

To install an NGX-1-USB to a PC/Laptop please follow these steps (also see page 9)

- Connect the M12 5-pin connector to a spare port on the NMEA 2000 network. An extension trunk-drop cable may be required iPlug the USB cable into a spare USB port on the PC / Laptop.
- Drivers should install automatically, but if they do not, please see the note on page 8 regarding driver installation.
- Open the required compatible app. (NMEA reader, Navigation apps etc) on the PC / laptop.
- Select the correct COM port for the NGX-1-USB as reported in the device manager.
- Make any other adjustments within the software as required.

Swapping between modes of operation (Transfer <-> Convert)

The **NGX-1** has been designed to cater for most use cases that will occur in a marine environment which relate to NMEA 0183 & NMEA 2000 data transfer and / or conversion.

- By default the NGX-1 is set to 'Convert' mode allowing immediate bi-directional conversions from NMEA 0183 sentences to NMEA 2000 PGN's.
- The NGX-1 will auto-baud to any baud rate between 4,800 and 230,400 baud in 'Convert' mode. This allows the NGX to automatically adjust to any commonly used baud rates without the need for any further configuration.

The NGX can be switched to 'Transfer' mode to transfer NMEA 2000 data to PC. Supported PC applications (e.g. Actisense NMEA Reader, Supported Chartplotter Apps etc.) will automatically change the NGX-1 into 'Transfer' mode. In 'transfer' mode it will use 115,200 by default but will autobaud to 230,400 to allow 'Transfer' of all PGN's even on a busy NMEA 2000 bus.

The baud rate can be manually changed and the NGX-1 will remember the last used baud rate for each mode.

Note: If a PC application has switched the NGX-1 into 'Transfer' mode, it can easily be switched back into 'Convert' mode by either:

- Power cycling
- Using NMEA reader
- Using Actisense Toolkit

Altering the modes is achieved using the NMEA Reader software which can be downloaded from our website using the link on page 8. See page 16 for details of connecting to NMEA Reader.

NMEA Reader provides a drop-down box which allows either mode to be selected as shown below.

You simply need to toggle between whichever mode is required.(Undefined & Transfer Normal n/a)

Transition between each mode is shown by the status light changing to either ● or ● (flashing)

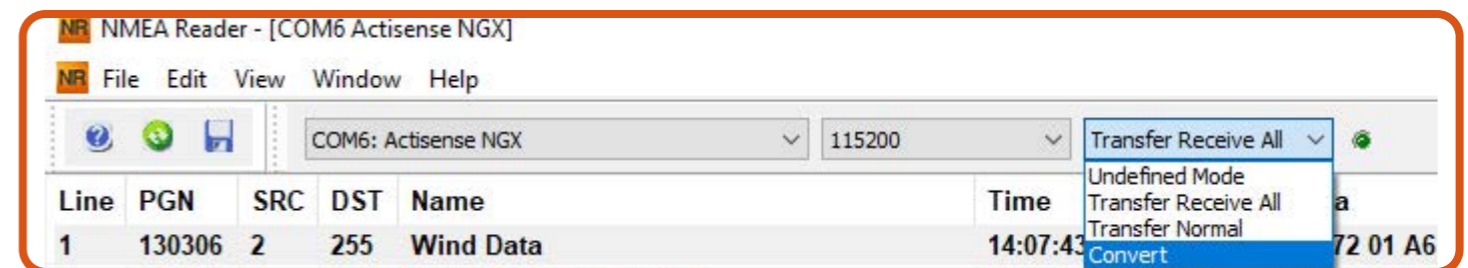
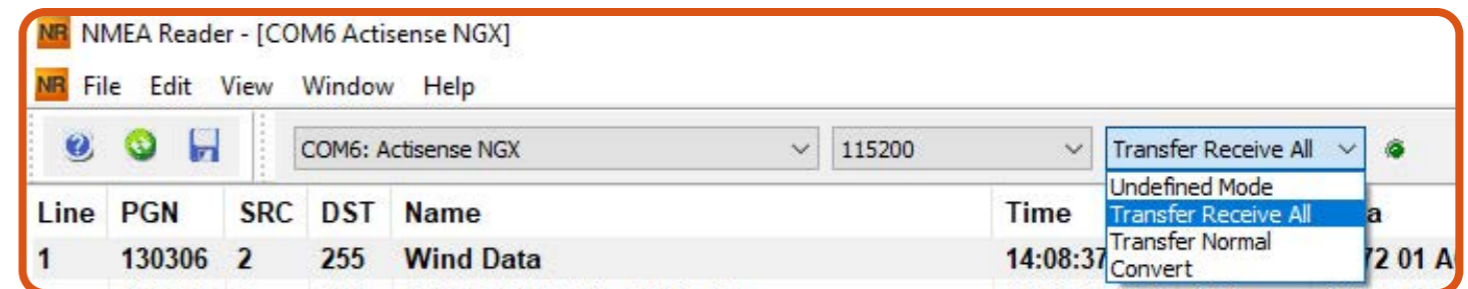

In addition to a change of Mode, the baud rate may also require alteration. This can be achieved using the instructions overleaf.

Manual baud rate alteration with NMEA Reader

Please download and install NMEA Reader from the Actisense website using the link below. Please ensure that you download the version applicable to your OS (64-bit or 32-bit).

- https://actisense.com/acti_software/nmea-reader/
- Run NMEA Reader and select the USG-serial converter connected to the NGX-1-ISO. ①

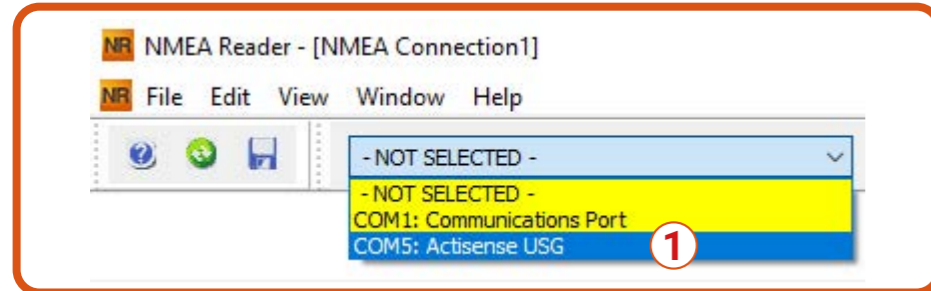

- Select the "Network View" tab at the bottom of the window to display all attached devices ②

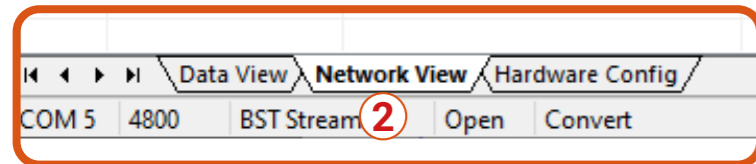

- The NGX-1-ISO should now be displayed as the only device on the network, with the default configuration of 4,800 baud and set to 'Convert' mode.

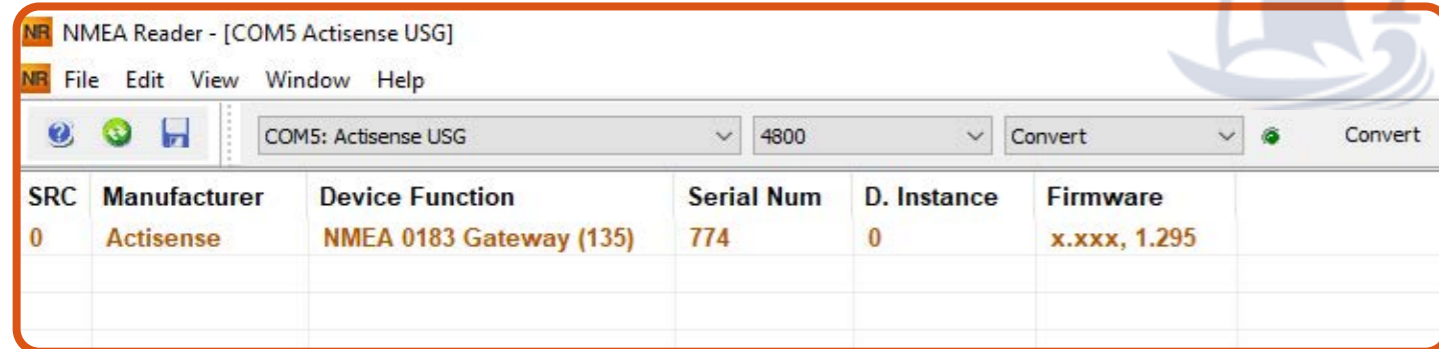

- Select the "Hardware Config" tab at the bottom of the window to change the baud rate. ③

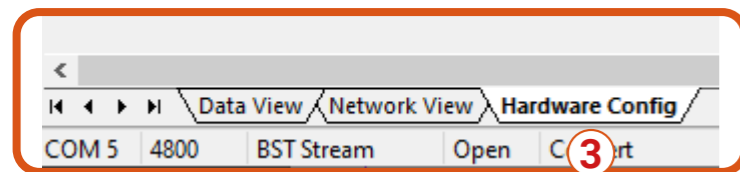

Manual baud rate alteration with NMEA Reader (cont'd)

- To change the baud rate, select the required baud rate (38,400 for an AIS device) from the drop-down menu and click "Apply" ④

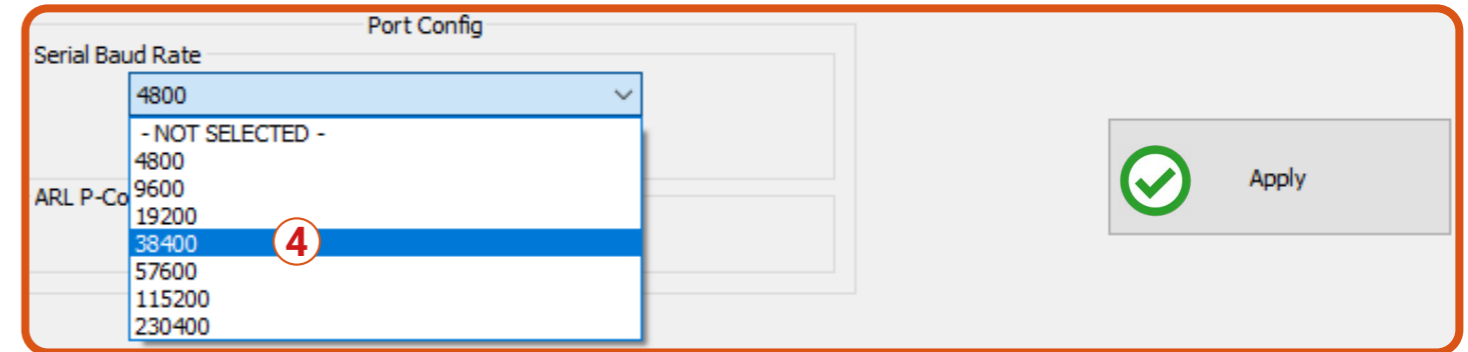

- After a short delay (approx.20 Seconds) the baud rate of the NGX-1-ISO will be changed to the desired baud rate, and this change will be reflected on the display as shown below. The mode of the NGX-1-ISO will remain in 'Convert' as before. "Device being configured" will show as "Local NGX".

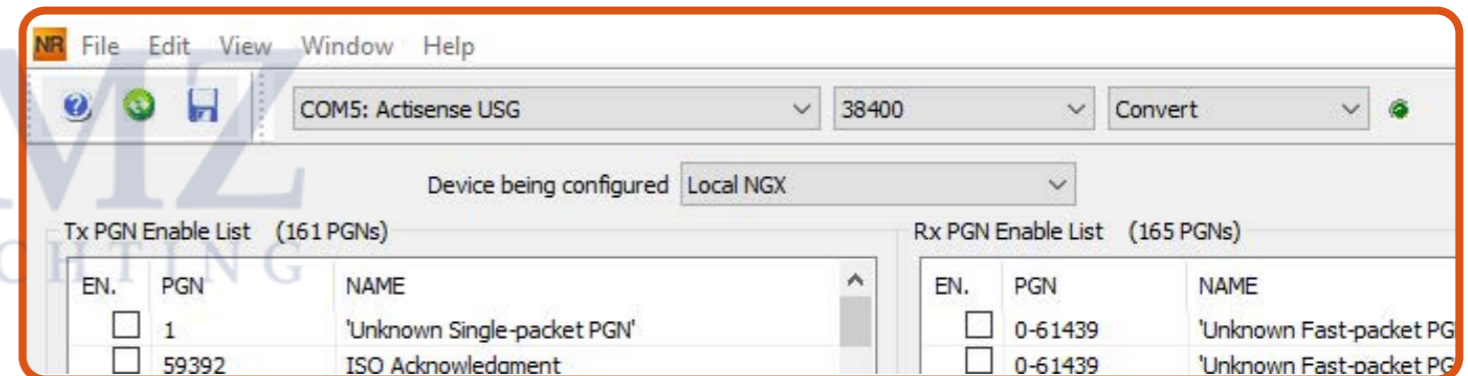

- Should you require to change the baud rate back to 4,800 at any time, the procedure to follow is identical to that shown above, selecting 4,800 instead and clicking "Apply".
- For more information regarding NMEA reader please download the manual from the link below.
- <https://actisense.com/wp-content/uploads/2020/01/NMEA-Reader-EBL-Reader-User-Manual-Issue-1.00-1.pdf>

Conversion settings using Actisense Toolkit

Please download and install Actisense Toolkit from the Actisense website using the link below. Please ensure you download the version applicable to your own OS (64-bit or 32-bit).

- https://actisense.com/acti_software/toolkit/

- Further information regarding Toolkit functionality is available within toolkit here:

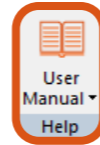

As previously mentioned on page 7, most of the normally required conversions are already set-up for the user, but there may be an occasion when some additional configuration is required. The reasons for this may include:

- VDO & VDM Tx conversions are required to be converted from NMEA 2000 to NMEA 0183 at 38,400 baud.
- The requirement to include a conversion not currently set (either 0183 or 2000)
- To set up a conversion for “Fast Heading”.
- To turn off a conversion which is not required.
- The requirement to reduce the volume of data which is being converted by turning off several messages.

Using the Actisense Toolkit is the method by which this can be achieved.

Run Actisense Toolkit and select the port through which you are connecting to the NGX-1 (ISO or USB). This will either be via an NGX-1-USB or a USB-serial converter depending on the device. ①

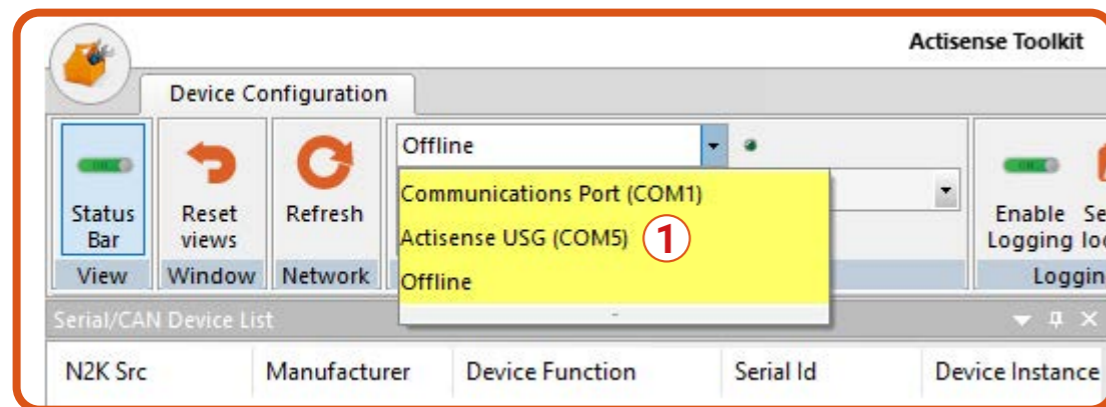

- The NGX-1 will now be displayed within the “Serial/CAN Device List” tab. If this is not visible please press the “Reset views” icon to reset the default windows. ②

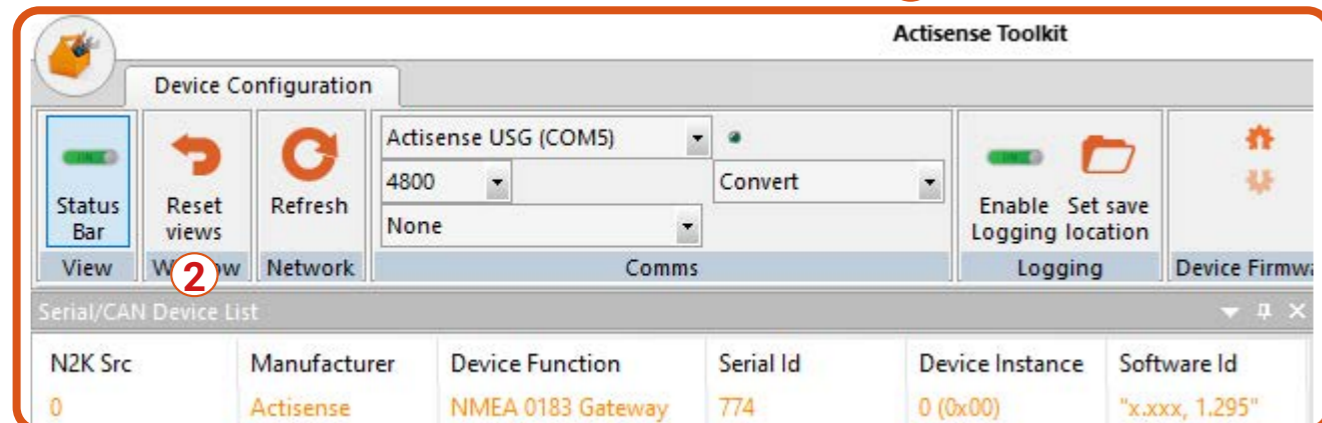

Conversion changes using Actisense Toolkit (cont'd)

- Highlight the NGX-1 and click the “Load From Device” icon on the top ribbon ③

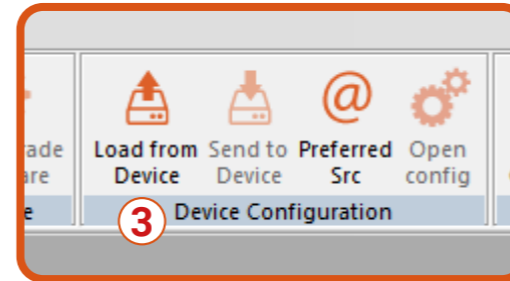

- The current configuration of the NGX-1 will now be loaded into Toolkit to be displayed to the user to allow changes to be made. This current configuration will be presented as shown below.
- There are several items shown below, and some of these are applicable to other Actisense products only. The areas of interest are the NMEA 0183 & NMEA 2000 tabs which display the Rx & Tx sentences and PGN's which can be turned on/off.

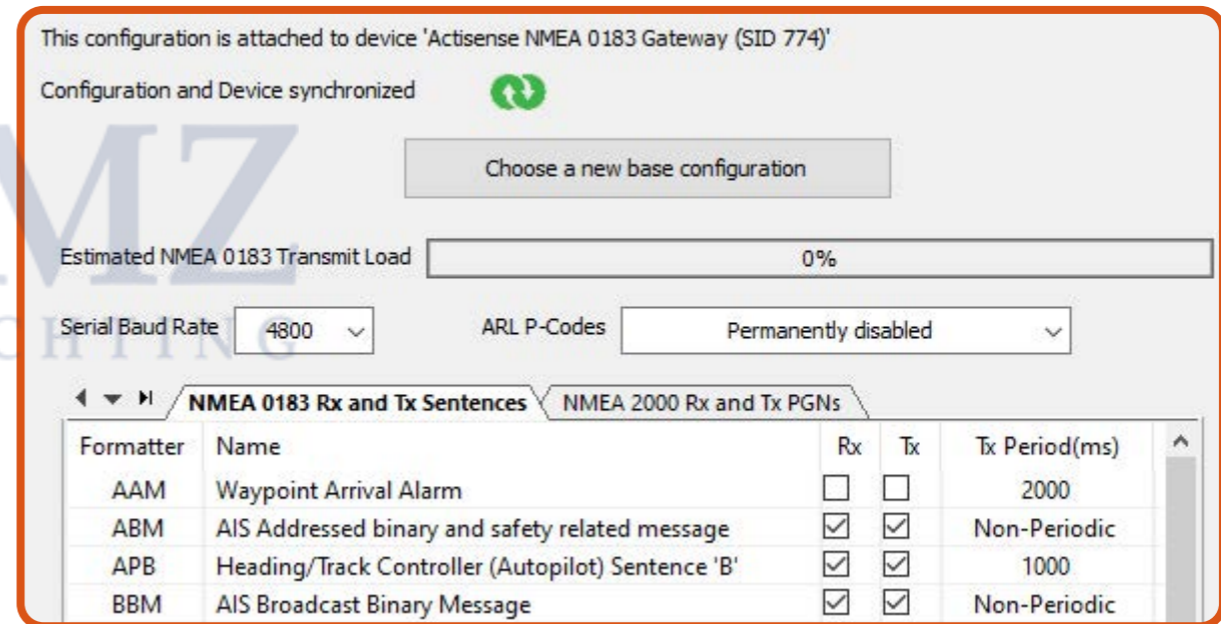

- Turning on / off the Rx or Tx messages is simply a matter of adding a tick or leaving the box blank. See page 20 for a detailed explanation of Rx & Tx conversion settings.
- You can also, at this point, alter the Tx period (the transmission rate) of the signal by clicking the value shown next to the **Tx Period(ms)** box and you will be presented with a choice of new values.
- Non-periodic statements cannot be altered as they have no regular frequency.
- To commit any changes to the NGX-1, press “Send to Device” from the top ribbon ④

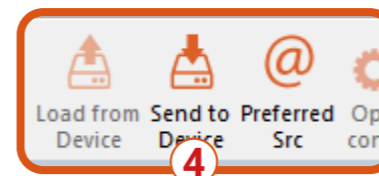

- Please see page 20 for an explanation of the Rx & Tx conversions and how to make sure that the correct conversions are married together for proper conversion to take place.

Explanation of Tx & Rx lists and how to configure the NGX-1

When an NGX-1 configuration is loaded from the device, the user is presented with two columns of Rx & Tx values which represent the NMEA 0183 sentences and NMEA 2000 messages which the NGX-1 is capable of converting. A screenshot of each is shown below.

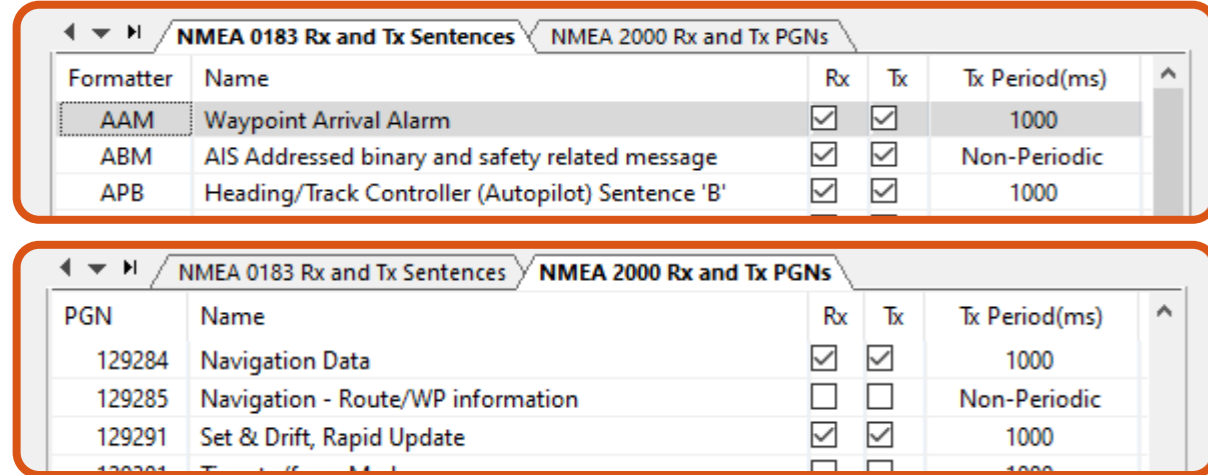

The NGX-1 offers the user considerable flexibility over what data will be converted, allowing messages to be blocked if not required, and also control over the transmit frequency (Tx period(ms)).

The graphic below outlines the data path and direction for each of the Rx & Tx pairs, and the effect of ticking the 'check box' or leaving it blank.

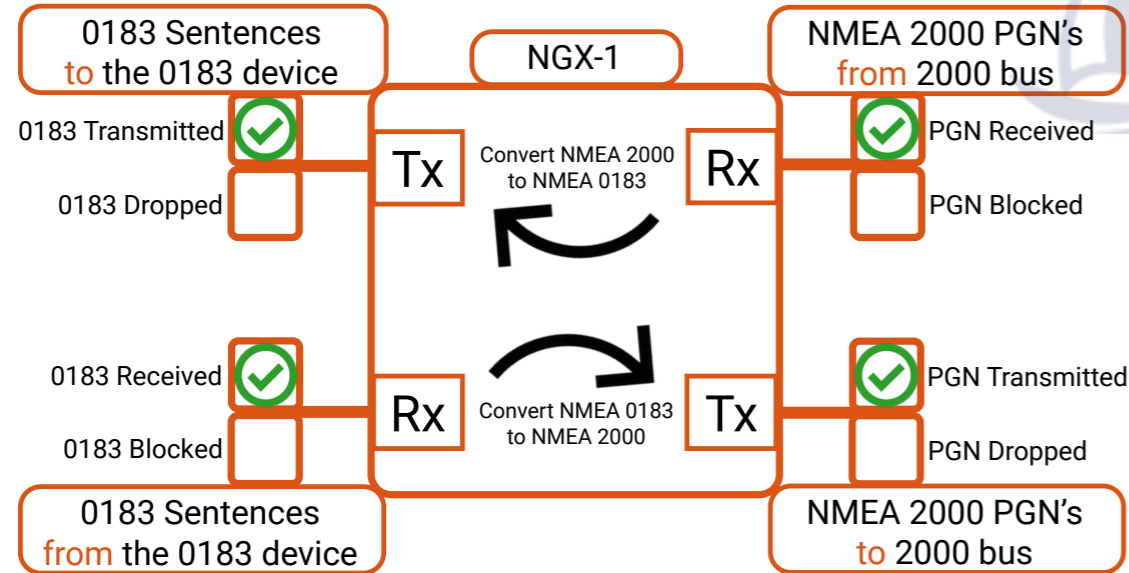

For a successful conversion to take place, you need to make sure that the required NMEA 0183 sentence to be converted is not only checked on the NMEA 0183 side to receive(Rx), but also that the corresponding PGN message is ticked for transmission onto the NMEA 2000 bus(Tx). A PGN cannot be transmitted onto the NMEA 2000 bus if it has not first been received from the 0183 device. The same convention applies for conversions from NMEA 2000 to NMEA 0183.

Using this configuration method allows the user very precise control of exactly which data is passed through the NGX-1, helping increase bandwidth, and eliminating unrequired conversions. A full list of all the conversions which the NGX-1 caters for can be found on the Actisense website using this link.

<https://actisense.com/downloads/?type=&product=.pro-16546>

Firmware updates using Actisense Toolkit

The NGX-1 can be updated using Toolkit when in either mode of operation. For a faster update, it is recommended that the baud rate of the NGX-1 is set to 230,400 baud, so please see the instructions for altering the baud rate on page 16-17 should this be required.

To update the firmware follow steps listed below.

- From the Actisense website, download the .ZIP file which will contain the required update to the NGX-1. This will be posted onto the website as and when it becomes available or as directed by technical support. Save this into a folder on your PC / Laptop.
- Connect the NGX-1 with Toolkit selecting the correct COM port and baud rate in the drop down box from the top ribbon bar.
- If a listing of the devices connected to the bus does not immediately show, press the “Refresh” Icon shown below.

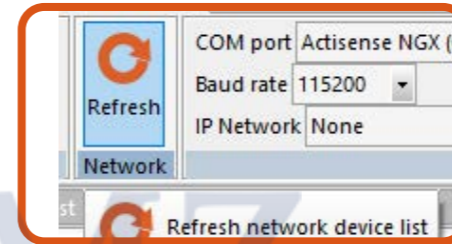

- Highlight the line from the device list containing the NGX-1 which you wish to update.
- Press the “Upgrade Firmware” Icon from the top ribbon bar as shown below.

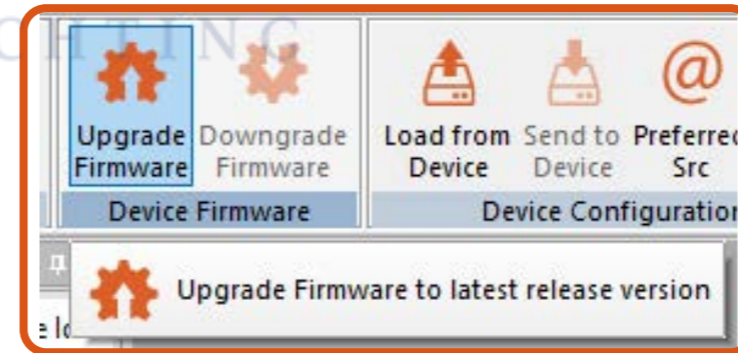

- Windows explorer will open a new window looking for the .ZIP previously downloaded from the Actisense website. Select the file.
- A new blank window will open with the option to either “program” or “cancel”. Press “program” to proceed with the firmware upgrade.
- Once the update had completed, the window will close and return control of Toolkit to the user.
- **The Blue LED will flash fast indicating FW update is in progress. Please note that the device will continue to process the file once the update has completed. Please wait for the device to reset. Do not remove power to the device during this process**

Manual installation of firmware updates

The NGX-1 provides the facility to update the device firmware using a micro SD card slot mounted on upper side of the PCB (Micro SD card not provided).

Referring to the image below, please follow the steps given to update the firmware on the NGX-1. This applies to both ISO and USB versions.

- Using a blank Micro SD card, create a directory called "Update".
- Into this directory copy the firmware .zip file available from the Actisense website at the following link <https://actisense.com/downloads/?type=&product=.pro-16546>
- Power the unit down and remove the NGX-1 from the network.
- **WARNING:** Please try and observe ESD precautions when handling the PCB to avoid static discharge.
- Carefully remove the two screws from the end-cap and withdraw it from the housing until the micro SD card holder is visible.
- Insert the SD card into the SD card slot and push to lock it in place.
- Replace the end-cap into position making sure that the waterproof gasket seals correctly. Fix the device closed with the two screws.
- Re-attach the device to the network and power the NGX-1 to start the update process.
- The blue "power" LED will flash rapidly while the update process is in progress and, once updated, the .zip file will be deleted from the SD card to prevent a repeated update on next power up.
- Note: All previous settings which have been applied such as baud rates and applied conversions are not affected by the firmware update.

Note: Users may find that the manual update of firmware using the SD card can be quicker. Using the SD card provides an update solution if access to toolkit is not available..

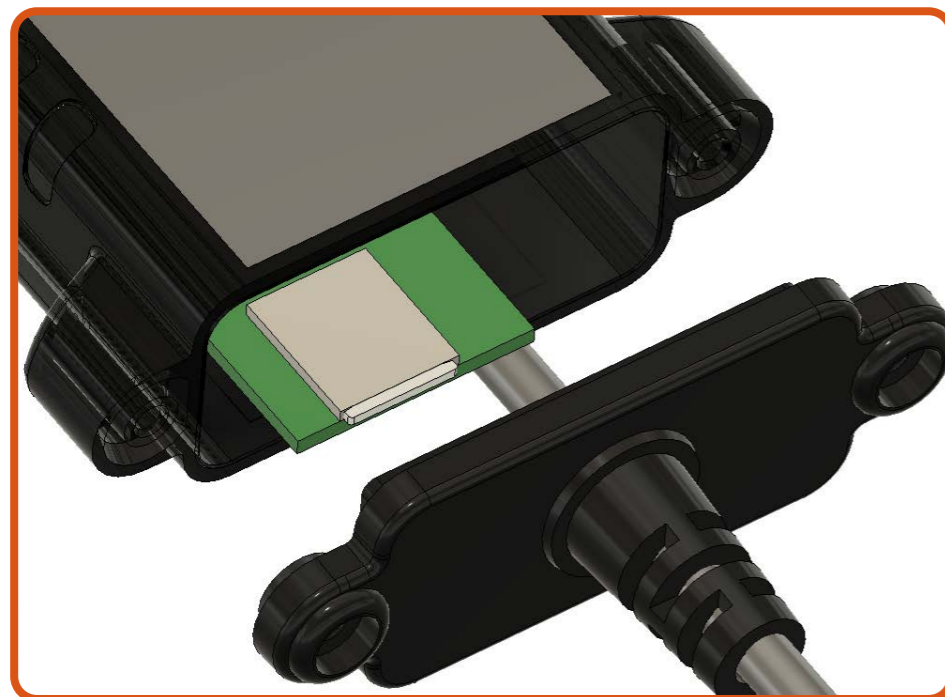

LED Behaviour and Troubleshooting

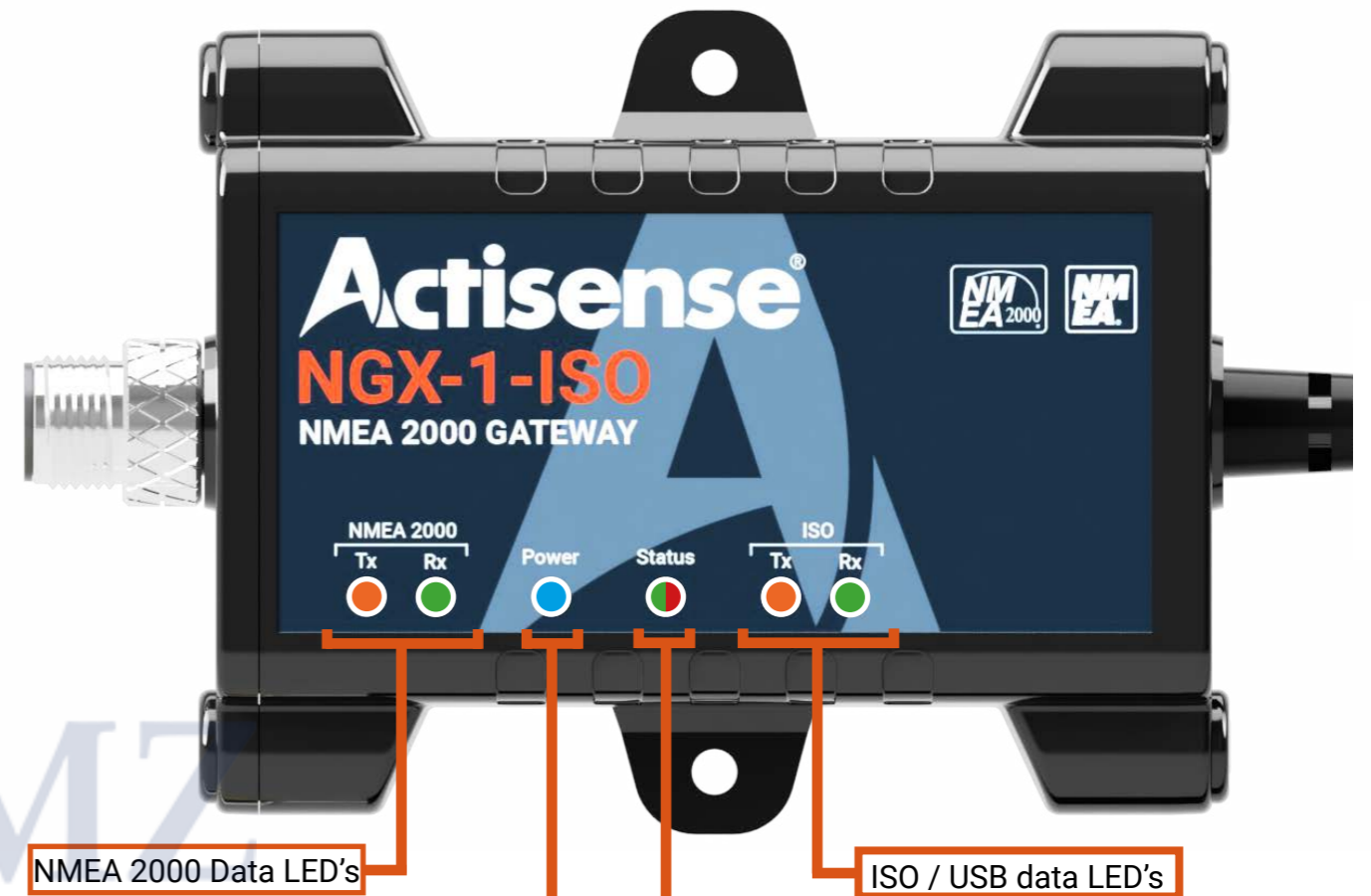

NMEA 2000 Data LED's

ISO / USB data LED's

- Power:**
- BLUE (pulsing) - Normal operation
 - BLUE (fast flashing) - F/W Update

- Device Status:**
- RED(solid) - Transfer rx Normal
 - RED(flashing) - Transfer rx All
 - GREEN - Converter mode

The following table summarises the LED operation:

Name	Power	NMEA 2000		Status	Serial / NMEA 0183	
		Tx	Rx		Tx	Rx
Colour	Blue	Orange	Green	Green Red Yellow	Orange	Green
Self-test	On solid	On solid	On solid	Solid Yellow	On solid	On solid
Actisense Bootloader	Flashing Fast (5Hz)	Flashes on Data Transmit	Flashes on Data Receive	Off	Flashes on Data Transmit	Flashes on Data Receive
Firmware Update / OTA	Flashing Super-Fast (10Hz)	Off	Off	Off	Off	Off
Convert (NGW) mode	Pulsing (2s)	Flashes on Data Transmit	Flashes on Data Receive	Solid Green	Flashes on Data Transmit	Flashes on Data Receive
Transfer (NGT) mode	Pulsing (2s)	Flashes on Data Transmit	Flashes on Data Receive	Solid Red	Flashes on Data Transmit	Flashes on Data Receive
Transfer (NGT) "Receive All" mode	Pulsing (2s)	Flashes on Data Transmit	Flashes on Data Receive	Flashing Red, Slow (1Hz)	Flashes on Data Transmit	Flashes on Data Receive

Technical Support and the Returns Procedure

All installation instructions and any warnings contained in this manual must be followed before contacting Actisense technical support. If the troubleshooting guide did not help resolve the problem and an error persists, please contact Actisense technical support to help trace the issue before considering the return of the product. If Actisense support concludes that the NGX-1 unit should be returned to Actisense, a Returns Number(RMA #)will be issued by the support engineer.

The Returns Number must be clearly visible on both the external packaging and any documentation returned with the product. Any returns sent without a Returns Number will incur a delay in being processed and a possible charge.

Technical Specification

Power Supply (NGX-1-ISO / NGX-1-USB)	
Supply Voltage (NMEA 2000 Port)	9 to 30V DC
Supply Current (NMEA 2000 Port)	62mA @ 9V DC
Load Equivalent Number (LEN)	2
Power Supply (USB Variants)	
Supply Voltage (NMEA 2000 Port)	9 to 30V DC
Supply Current (USB Host Port)	10mA @ 5V DC
Supply Current (NMEA 2000 Port)	62mA @ 9V DC
Load Equivalent Number (LEN)	2
NMEA 2000 Port (NGX-1-ISO / NGX-1-USB)	
Speed / Baud Rate	250kbps
Connectivity	M12 Male (A coded)
ISO Port (NGX-1-ISO)	
Compatibility	Full NMEA 0183, RS232 & RS422 compatibility. RS485 Listener compatible
Speed/Baud Rate	4800 to 230400 Baud
Output Voltage Drive	>= 2.1V (differential) into 100Ω
Output Current Drive	20mA max.
Output Protection	Short circuit and ESD
Input Voltage Tolerance	-15V to +15V continuous -35V to +35V short term (< 1 second)
Input Protection	Current limited and overdrive protection to 40VDC
Connectivity	5mm stripped and tinned wire
Cable Length	0.75m
USB Port (USB Variant)	
Compatibility	USB 1.1, 2.0 and 3.0
Speed / Baud Rate	4800 to 230400 Baud
Connectivity	Male type A plug moulded onto cable
Cable Length	1.8m
Isolation	
NMEA 2000 Port to ISO Port	Uses IsoDrive™, Hi-Pot tested to 1000V
NMEA 2000 Port to USB Port	Galvanic Isolation, Hi-Pot tested to 1000V
Mechanical	
Housing Material Body	Flame retardant Polycarbonate
Housing Material End Caps	Flame retardant PBT
Weight NGX-1-ISO	112g
Weight NGX-1-USB	113g
Approvals and Certifications	
NMEA 2000	NMEA 2000 Certified
NMEA 0183	Meets IEC 61162-1 & 61162-2 Requirements
RoHS and REACH	Compliant

Module Certification	KCC / BQB / IC / Wi-Fi / NCC / MIC / FCC DSS / FCC DTS / SRRC / CE
EMC	EN 60945:2002 Edition 4 (section 9.3) EN 301 489-1 V2.2.3 EN 301 489-17 V3.2.4 EN 300 328 V2.2.2 Radiated Spurious Emissions FCC Part 15b ICES-003 Iss 7
Environmental Protection	IP68
Operating Temperature	-25°C to +70°C
Storage Temperature	-30°C to +70°C
Recommended Humidity	0 to 93% RH @ 40°C
Guarantee	3 years, extended to 5 years upon registration

Note: Contains a Wi-Fi module which is DISABLED. Freq Band 2412-2484MHz, Max output Power 19.22dBm, int. antenna 3.4dBi

NGX-1 Dimensions

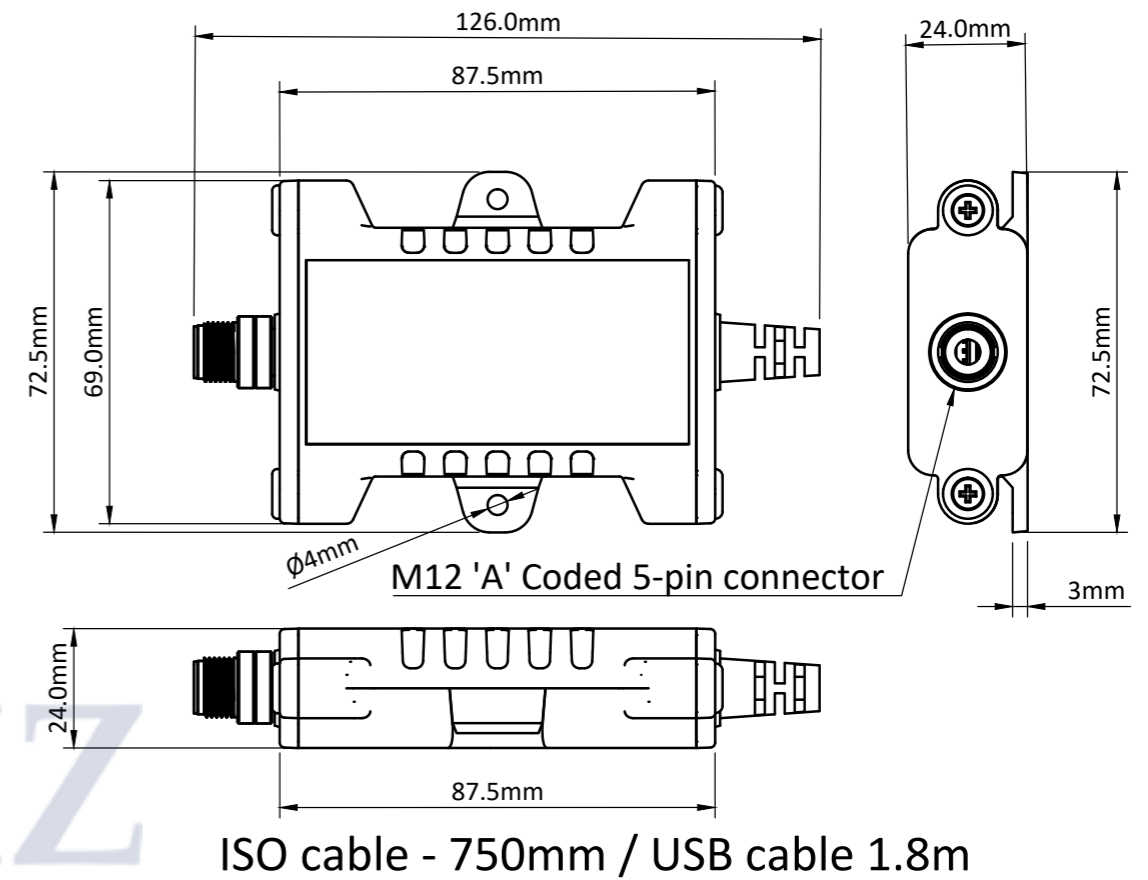



Active Research Ltd
21 Harwell Road
Poole, Dorset
UK BH17 0GE

Telephone: +44 (0)1202 746682
Email: sales@actisense.com
Web: www.actisense.com